

XS1M30MA250

Inductive proximity sensors XS, inductive sensor XS1 M30, L60mm, brass, Sn10mm, 24...240VAC/DC, cable 2 m



Main

Range of product	Telemecanique Inductive proximity sensors XS
Series name	General purpose
Sensor type	Inductive proximity sensor
Wiring configuration	2-wire
Output circuit type	AC/DC
Protection type	Short-circuit protection multi voltage
Device application	2-wire DC short-circuit protection
Sensor name	XS1
Sensor design	Cylindrical M30
Size	60 mm
Body type	Fixed
Detector flush mounting acceptance	Flush mountable
Material	Metal
Type of output signal	Discrete
Wiring technique	2-wire
[Sn] nominal sensing distance	10 mm
Discrete output function	1 NO
Electrical connection	Cable
Cable length	2 m
[Us] rated supply voltage	24...210 V DC 24...240 V AC 50/60 Hz
Switching capacity in mA	5...300 mA AC with overload and short-circuit protection 5...200 mA DC with overload and short-circuit protection
IP degree of protection	IP68 double insulation conforming to IEC 60529

Complementary

Thread type	M30 x 1.5
Detection face	Frontal
Front material	PPS
Enclosure material	Nickel plated brass
Operating zone	0...8 mm
Differential travel	1...15% of Sr
Cable composition	2 x 0.34 mm ²
Wire insulation material	PVC
Status LED	Output state: 1 LED (yellow) Supply on: 1 LED (green)
Supply voltage limits	20...264 V AC/DC
Maximum residual current	1.5 mA open state
Switching frequency	<= 2000 Hz DC <= 25 Hz AC
Maximum voltage drop	<5.5 V (closed state)
Maximum delay first up	70 ms
Maximum delay response	2 ms
Maximum delay recovery	5 ms

Marking	CE
Threaded length	51 mm
Length	60 mm
Net weight	0.205 kg

Environment

Product certifications	UL[RETURN]CSA[RETURN]CCC
Ambient air temperature for operation	-25...70 °C
Ambient air temperature for storage	-40...85 °C
Vibration resistance	25 gn amplitude = +/- 2 mm (f = 10...55 Hz) conforming to IEC 60068-2-6
Shock resistance	50 gn for 11 ms conforming to IEC 60068-2-7

Packing Units

Unit Type of Package 1	PCE
Number of Units in Package 1	1
Package 1 Height	13.200 cm
Package 1 Width	9.500 cm
Package 1 Length	4.100 cm
Package 1 Weight	190.000 g
Unit Type of Package 2	S03
Number of Units in Package 2	44
Package 2 Height	30 cm
Package 2 Width	30 cm
Package 2 Length	40 cm
Package 2 Weight	8.832 kg

Offer Sustainability

Sustainable offer status	Green Premium product
Circularity Profile	 End of Life Information
California proposition 65	WARNING: This product can expose you to chemicals including: Diisononyl phthalate (DINP), which is known to the State of California to cause cancer, and Di-isodecyl phthalate (DIDP), which is known to the State of California to cause birth defects or other reproductive harm. For more information go to www.P65Warnings.ca.gov
For all Reach Rohs enquiries contact us at	sustainability@tesensors.com

Contractual warranty

Warranty	18 months
----------	-----------

Dimensions

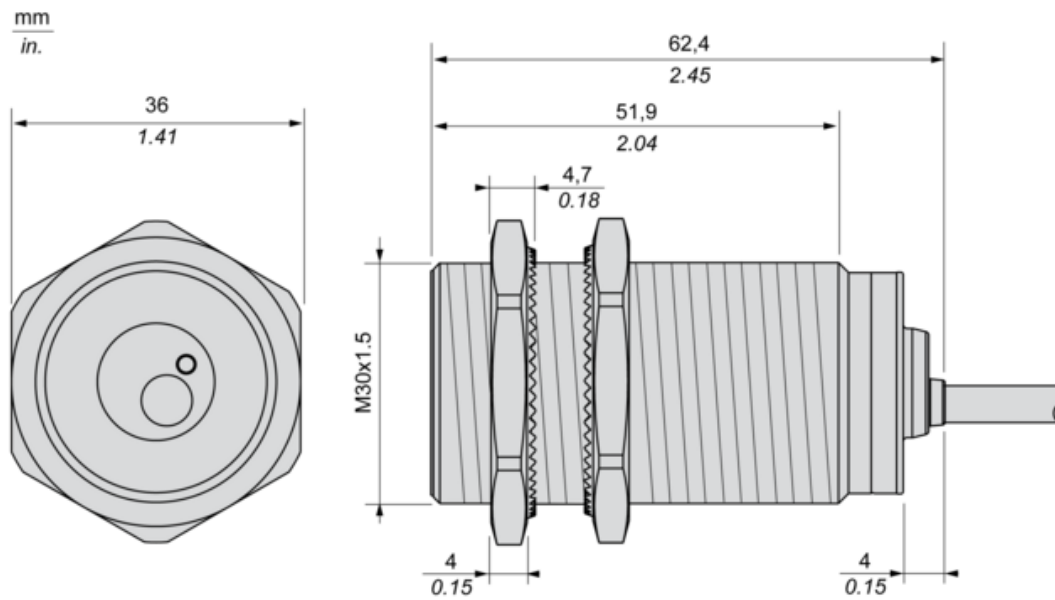

Minimum Mounting Distances

Side by side

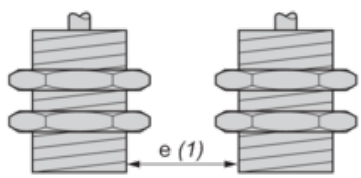

$e (1) \geq 20 \text{ mm}/0.79 \text{ in}$

Face to face

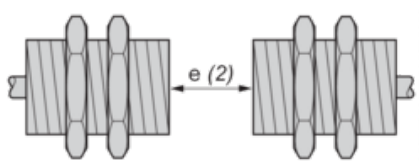

$e (2) \geq 120 \text{ mm}/4.72 \text{ in}$

Facing a metal object

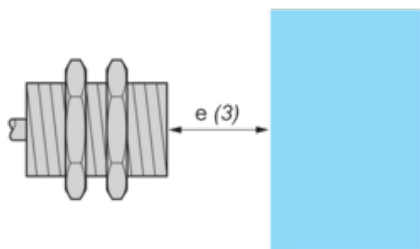

$e (3) \geq 30 \text{ mm}/1.18 \text{ in.}$

Wiring Schemes

2-Wire AC or DC

NO output

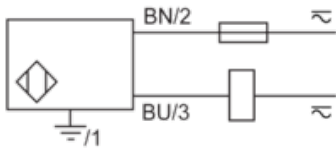

BU : Blue

BN : Brown

Performance Curves

Standard Steel Target : 30x30x1 mm

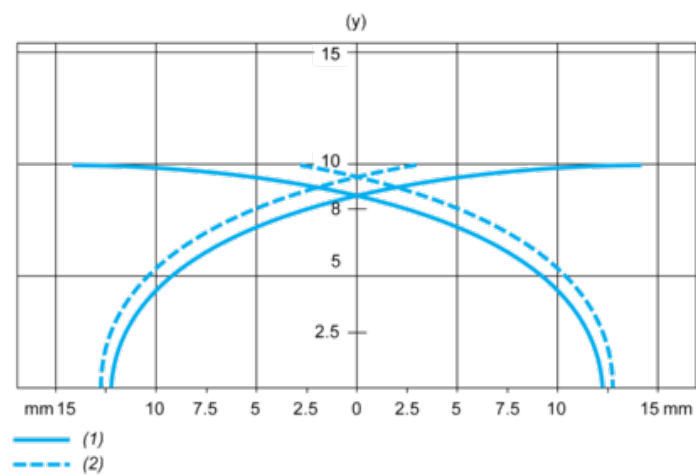

- (1) Pick-up points
- (2) Drop-out points (object approaching from the side)
- (y) Sensing distance in mm